

3000W,5 - 220V Transient Voltage Suppressors

Features

- Very fast response time
- Glass passivated junction
- Excellent clamping capability
- Moisture sensitivity: level 1, per J-STD-020
- Available in unidirectional and bidirectional
- Plastic package has underwriters Laboratory Flammability Classification 94V-0
- 3000 W peak pulse power capability with a 10/1000 μ s waveform

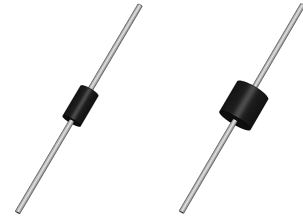

R-6/P600

Applications

- SMPS
- Adapters
- Monitor

Absolute Maximum Ratings ($T_A=25^\circ\text{C}$ unless otherwise noted)

Parameter	Symbol	Ratings	Unit
Peak power dissipation with a 10/1000us waveform	P_{PPM}	3000	W
Peak pulse current with a 10/1000us waveform	I_{PPM}	See Next Table	A
Power dissipation, on infinite heat sink at $T_L=75^\circ\text{C}$	P_D	8	W
Peak forward surge current, 8.3ms single half-sine wave	I_{FSM}	250	A
Operating junction and storage temperature range	T_J, T_{STG}	-55 to +175	$^\circ\text{C}$

Note:

1. Valid provided that leads at a distance of 9.5 mm from case are kept at ambient temperature.



Electrical Characteristics (TA = 25 °C unless otherwise noted)

Part Number (Uni)	Part Number (Bi)	Breakdown Voltage VBR (Volts)		Test Current I _T (mA)	Stand off Voltage V _{WM} (Volts)	Maximum reverse leakage at V _{WM} I _D (μA)	Maximum Peak Pulse Current I _{PPM} (A)	Maximum Clamping Voltage at I _{PPM} V _C (Volts)
		Min	Max					
3KP5.0	3KP5.0C	6.40	7.55	10.0	5	2000	312.5	9.6
3KP5.0A	3KP5.0CA	6.40	7.25	10.0	5	2000	326.0	9.2
3KP6.0	3KP6.0C	6.67	8.45	10.0	6	5000	263.2	11.4
3KP6.0A	3KP6.0CA	6.67	7.67	10.0	6	5000	291.3	10.3
3KP6.5	3KP6.5C	7.22	9.14	10.0	6.5	2000	243.9	12.3
3KP6.5A	3KP6.5CA	7.22	8.30	10.0	6.5	2000	267.9	11.2
3KP7.0	3KP7.0C	7.78	9.86	10.0	7	1000	225.6	13.3
3KP7.0A	3KP7.0CA	7.78	8.95	10.0	7	1000	250.0	12.0
3KP7.5	3KP7.5C	8.33	10.67	1.0	7.5	250	209.8	14.3
3KP7.5A	3KP7.5CA	8.33	9.58	1.0	7.5	250	232.6	12.9
3KP8.0	3KP8.0C	8.89	11.30	1.0	8	150	220.0	15.0
3KP8.0A	3KP8.0CA	8.89	10.23	1.0	8	150	220.6	13.6
3KP8.5	3KP8.5C	9.44	11.92	1.0	8.5	50	188.8	15.9
3KP8.5A	3KP8.5CA	9.44	10.82	1.0	8.5	50	208.4	14.4
3KP9.0	3KP9.0C	10.0	12.6	1.0	9	20	177.4	16.9
3KP9.0A	3KP9.0CA	10.0	11.5	1.0	9	20	194.8	15.4
3KP10	3KP10C	11.1	14.1	1.0	10	15	159.6	18.8
3KP10A	3KP10CA	11.1	12.8	1.0	10	15	176.4	17.0
3KP11	3KP11C	12.2	15.4	1.0	11	10	149.2	20.1
3KP11A	3KP11CA	12.2	14.0	1.0	11	10	184.88	18.2
3KP12	3KP12C	13.3	16.9	1.0	12	5.0	136.4	22.0
3KP12A	3KP12CA	13.3	15.3	1.0	12	5.0	150.6	19.9
3KP13	3KP13C	14.4	18.2	1.0	13	2.0	126.0	23.8
3KP13A	3KP13CA	14.4	16.5	1.0	13	2.0	139.4	21.5
3KP14	3KP14C	15.6	19.8	1.0	14	2.0	116.2	25.8
3KP14A	3KP14CA	15.6	17.9	1.0	14	2.0	129.4	23.2
3KP15	3KP15C	16.7	21.1	1.0	15	2.0	111.6	26.9
3KP15A	3KP15CA	16.7	19.2	1.0	15	2.0	123.0	24.4
3KP16	3KP16C	17.8	22.6	1.0	16	2.0	104.2	28.8
3KP16A	3KP16CA	17.8	20.5	1.0	16	2.0	115.4	26.0
3KP17	3KP17C	18.9	23.9	1.0	17	2.0	98.4	30.5
3KP17A	3KP17CA	18.9	21.7	1.0	17	2.0	106.6	27.6
3KP18	3KP18C	20.0	25.3	1.0	18	2.0	93.2	32.2
3KP18A	3KP18CA	20.0	23.3	1.0	18	2.0	102.8	29.2



Electrical Characteristics (TA = 25 °C unless otherwise noted)

Part Number (Uni)	Part Number (Bi)	Breakdown Voltage VBR (Volts)		Test Current I _T (mA)	Stand off Voltage V _{WM} (Volts)	Maximum reverse leakage at V _{WM} I _D (μA)	Maximum Peak Pulse Current I _{ppM} (A)	Maximum Clamping Voltage at I _{ppM} V _C (Volts)
		Min	Max					
3KP20	3KP20C	22.2	28.1	1.0	20	2.0	83.8	35.8
3KP20A	3KP20CA	22.2	25.5	1.0	20	2.0	92.6	32.4
3KP22	3KP22C	24.4	30.9	1.0	22	2.0	76.2	39.4
3KP22A	3KP22CA	24.4	28.0	1.0	22	2.0	84.4	35.5
3KP24	3KP24C	26.7	33.8	1.0	24	2.0	69.8	43.0
3KP24A	3KP24CA	26.7	30.7	1.0	24	2.0	77.2	38.9
3KP26	3KP26C	28.9	36.6	1.0	26	2.0	64.4	46.6
3KP26A	3KP26CA	28.9	33.2	1.0	26	2.0	71.2	42.1
3KP28	3KP28C	31.1	39.4	1.0	28	2.0	60.0	50.1
3KP28A	3KP28CA	31.1	35.8	1.0	28	2.0	66.0	45.4
3KP30	3KP30C	33.3	42.2	1.0	30	2.0	56.0	53.5
3KP30A	3KP30CA	33.3	38.3	1.0	30	2.0	62.0	48.4
3KP33	3KP33C	36.7	46.5	1.0	33	2.0	50.4	59.0
3KP33A	3KP33CA	36.7	42.2	1.0	33	2.0	56.2	53.3
3KP36	3KP36C	40.0	50.7	1.0	36	2.0	46.6	64.3
3KP36A	3KP36CA	40.0	46.0	1.0	36	2.0	51.6	58.1
3KP40	3KP40C	44.4	56.3	1.0	40	2.0	42.0	71.4
3KP40A	3KP40CA	44.4	51.1	1.0	40	2.0	46.4	64.5
3KP43	3KP43C	47.8	60.5	1.0	43	2.0	39.2	76.7
3KP43A	3KP43CA	47.8	54.9	1.0	43	2.0	43.2	69.4
3KP45	3KP45C	50.0	63.3	1.0	45	2.0	37.4	80.3
3KP45A	3KP45CA	50.0	57.5	1.0	45	2.0	41.2	72.7
3KP48	3KP48C	53.3	67.5	1.0	48	2.0	35.0	85.5
3KP48A	3KP48CA	53.3	61.3	1.0	48	2.0	38.8	77.4
3KP51	3KP51C	56.7	71.8	1.0	51	2.0	37.0	91.1
3KP51A	3KP51CA	56.7	65.2	1.0	51	2.0	36.4	82.4
3KP54	3KP54C	60.0	76.0	1.0	54	2.0	31.2	96.3
3KP54A	3KP54CA	60.0	69.0	1.0	54	2.0	34.4	87.1
3KP58	3KP58C	64.4	81.6	1.0	58	2.0	29.2	103
3KP58A	3KP58CA	64.4	74.1	1.0	58	2.0	32.0	93.6
3KP60	3KP60C	66.7	84.5	1.0	60	2.0	28.0	107
3KP60A	3KP60CA	66.7	76.7	1.0	60	2.0	31.0	96.8
3KP64	3KP64C	71.1	90.1	1.0	64	2.0	26.4	114
3KP64A	3KP64CA	71.1	81.8	1.0	64	2.0	29.2	103



Electrical Characteristics (TA = 25 °C unless otherwise noted)

Part Number (Uni)	Part Number (Bi)	Breakdown Voltage VBR (Volts)		Test Current I _T (mA)	Stand off Voltage V _{WM} (Volts)	Maximum reverse leakage at V _{WM} I _D (μA)	Maximum Peak Pulse Current I _{ppM} (A)	Maximum Clamping Voltage at I _{ppM} V _C (Volts)
		Min	Max					
3KP70	3KP70C	77.8	98.6	1.0	70	2.0	24.0	125
3KP70A	3KP70CA	77.8	89.5	1.0	70	2.0	26.8	113
3KP75	3KP75C	83.3	105.7	1.0	75	2.0	22.4	134
3KP75A	3KP75CA	83.3	95.8	1.0	75	2.0	24.8	121
3KP78	3KP78C	86.7	109.8	1.0	78	2.0	21.6	139
3KP78A	3KP78CA	86.7	99.7	1.0	78	2.0	22.8	126
3KP85	3KP85C	94.4	119.2	1.0	85	2.0	19.8	151
3KP85A	3KP85CA	94.4	108.2	1.0	85	2.0	20.8	137
3KP90	3KP90C	100.0	126.5	1.0	90	2.0	18.8	160
3KP90A	3KP90CA	100.0	115.5	1.0	90	2.0	20.6	146
3KP100	3KP100C	111.0	141.0	1.0	100	2.0	16.6	179
3KP100A	3KP100CA	111.0	128.0	1.0	100	2.0	18.6	162
3KP110	3KP110C	122.0	154.5	1.0	110	2.0	15.4	196
3KP110A	3KP110CA	122.0	140.5	1.0	110	2.0	16.8	177
3KP120	3KP120C	133.0	169.0	1.0	120	2.0	14.0	214
3KP120A	3KP120CA	133.0	153.0	1.0	120	2.0	15.6	193
3KP130	3KP130C	144.0	182.5	1.0	130	2.0	13.0	231
3KP130A	3KP130CA	144.0	165.5	1.0	130	2.0	14.4	209
3KP150	3KP150C	167.0	211.5	1.0	150	2.0	11.2	268
3KP150A	3KP150CA	167.0	192.5	1.0	150	2.0	12.4	243
3KP160	3KP160C	178.0	226.0	1.0	160	2.0	10.4	287
3KP160A	3KP160CA	178.0	205.0	1.0	160	2.0	11.6	259
3KP170	3KP170C	189.0	239.5	1.0	170	2.0	9.8	304
3KP170A	3KP170CA	189.0	217.5	1.0	170	2.0	11.0	275
3KP180	3KP180C	196.0	253.8	1.0	180	2.0	9.3	322
3KP180A	3KP180CA	196.0	230.4	1.0	180	2.0	10.3	292
3KP190	3KP190C	209.0	267.9	1.0	190	2.0	8.8	340
3KP190A	3KP190CA	209.0	243.2	1.0	190	2.0	9.7	308
3KP200	3KP200C	220.0	282.0	1.0	200	2.0	8.4	358
3KP200A	3KP200CA	220.0	256.0	1.0	200	2.0	9.3	324
3KP210	3KP210C	231.0	296.1	1.0	210	2.0	7.8	376
3KP210A	3KP210CA	231.0	268.8	1.0	210	2.0	8.8	340
3KP220	3KP220C	242.0	310.2	1.0	220	2.0	7.6	394
3KP220A	3KP220CA	242.0	281.6	1.0	220	2.0	8.4	356

Ratings and Characteristics Curves

($T_A = 25^\circ\text{C}$ unless otherwise noted)

FIG.1-Peak Pulse Power Rating Curve

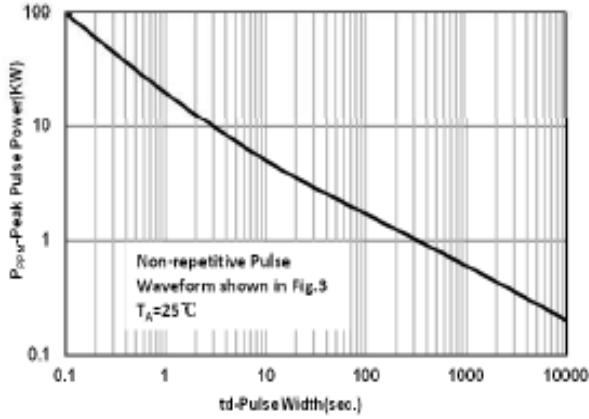

FIG.2-Pulse Derating Curve

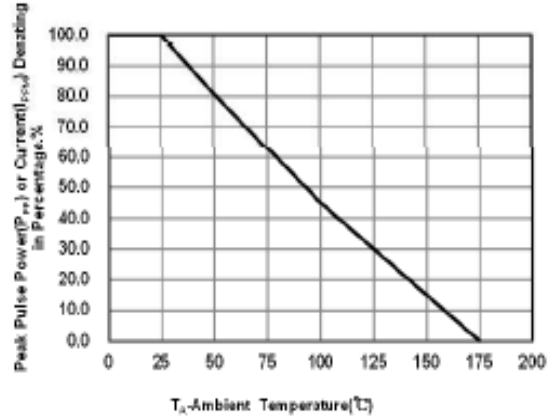

FIG.3-Pulse Waveform

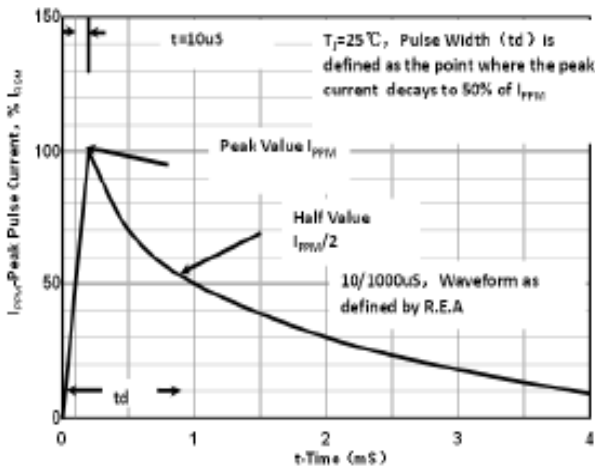

FIG.4-Typ Junction Capacitance Uni-Directional

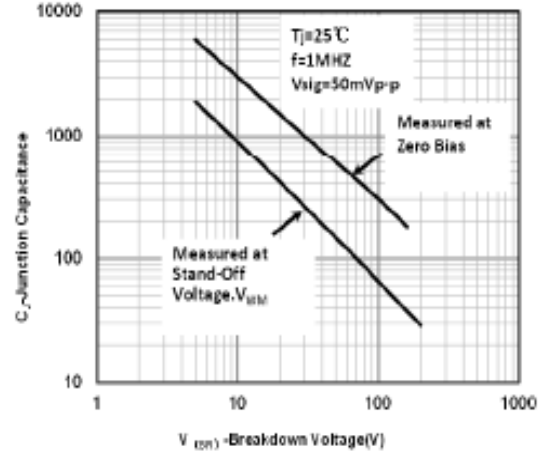

FIG5-Steady State Power Derating Curve

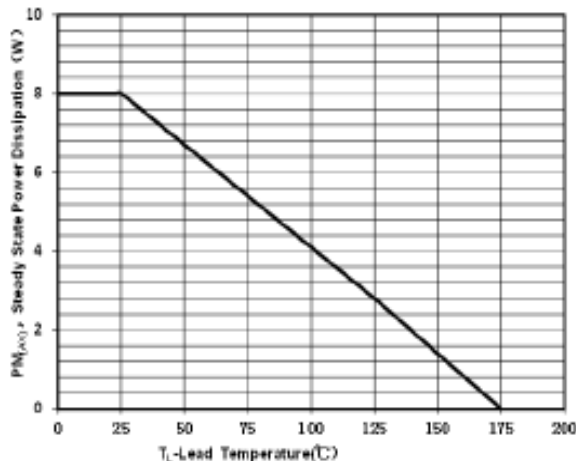
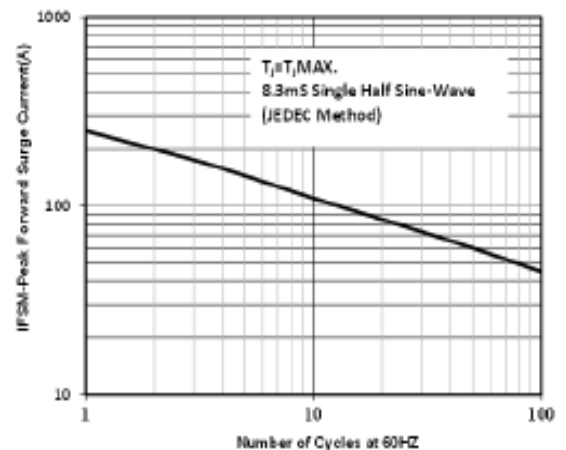

FIG6-Max.Non-Repetitive Forward Surge Current Uni-Directional Only



Package Outline Dimensions

in inches (millimeters)

R-6/P600

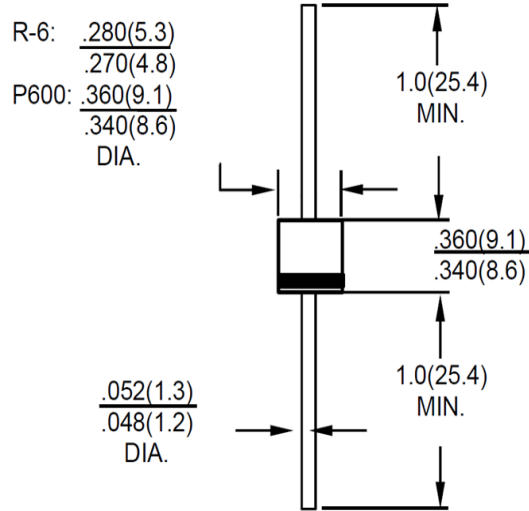

Dimensions in inches and (millimeters)

Revision History

Document Version	Date of release	Description of changes
Rev.A	2021.06.15	Released Datasheet
Rev.B	2023.11.28	Modify document format

Disclaimers

These materials are intended as a reference to assist our customers in the selection of the Suzhou Good-Ark product best suited to the customer's application; they do not convey any license under any intellectual property rights, or any other rights, belonging to Suzhou Good-Ark Electronics Co., Ltd. or a third party.

Suzhou Good-Ark Electronics Co., Ltd. assumes no responsibility for any damage, or infringement of any third-party's rights, originating in the use of any product data, diagrams, charts, programs, algorithms, or circuit application examples contained in these materials.

All information contained in these materials, including product data, diagrams, charts, programs and algorithms represents information on products at the time of publication of these materials, and are subject to change by Suzhou Good-Ark Electronics Co., Ltd. without notice due to product improvements or other reasons. It is therefore recommended that customers contact Suzhou Good-Ark Electronics Co., Ltd. or an authorized Suzhou Good-Ark Electronics Co., Ltd. for the latest product information before purchasing a product listed herein. The information described here may contain technical inaccuracies or typographical errors. Suzhou Good-Ark Electronics Co., Ltd. assumes no responsibility for any damage, liability, or other loss rising from these inaccuracies or errors. Please also pay attention to information published by Suzhou Good-Ark Electronics Co., Ltd. by various means, including our website home page.

(<http://www.goodark.com>)

When using any or all of the information contained in these materials, including product data, diagrams, charts, programs, and algorithms, Please be sure to evaluate all information as a total system before making a final decision on the applicability of the information and products. Suzhou Good-Ark Electronics Co., Ltd. assumes no responsibility for any damage, liability or other loss resulting from the information contained herein.

The prior written approval of Suzhou Good-Ark Electronics Co., Ltd. is necessary to reprint or reproduce in whole or in part these materials.

Please contact Suzhou Good-Ark Electronics Co., Ltd. or an authorized distributor for further details on these materials or the products contained herein.